

**SCIENCE****ANSWER AND SOLUTIONS****SECTION-A**

1. Option (3)
2. Option (2)
3. Option (4)
4. Option (3)
5. Option (1)
6. Option (2)
7. Option (1)
8. Option (4)
9. Option (3)
10. Option (3)
11. Option (2)
12. Option (2)
13. Option (4)

In reflection, the angle of incidence is equal to angle of reflection. So if angle of incidence increases, angle of reflection also increases in the same proportion.

14. Option (4)

Have refractive index exactly matching with that of the surrounding fluid. If the refractive index of the body becomes equal to surrounding liquid, there will not be any deviation in the direction of light neither will any light get reflected from its surface. So, the object becomes invisible.

15. Option (3)
16. Option (2)
17. Option (1)

Sodium hydrogen carbonate ( $\text{NaHCO}_3$ ) is used as an ingredient in antacids because being alkaline, it neutralises excess acid in the stomach and provides relief. It is a mild, non-corrosive salt.

18. Option (2)
19. Option (4)

Fuse wire is always connected in series to prevent the electrical appliances from damage due to unwanted high current in the circuit.

20. Option (2)

**SECTION-B**

21. Compound X is  $\text{NaCl(aq)}$ , which is an aqueous solution of sodium chloride in water. Gas Y is  $\text{H}_2$  (hydrogen gas), liberated at cathode.

Gas Z is  $\text{Cl}_2$ , (chlorine gas), liberated at anode.

The overall balanced chemical equation is:

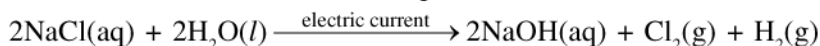

Treatment of gas Z ( $\text{Cl}_2$ ) with dry slaked lime,  $\text{Ca(OH)}_2$ , gives bleaching powder ( $\text{CaOCl}_2$ ).

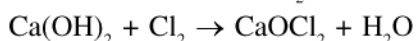

Hence, Compound B is  $\text{CaOCl}_2$

22. In absence of KOH, CO<sub>2</sub> released by germinating seeds is not absorbed, partial vacuum is not created in the conical flask, air pressure in the flask is not reduced, water level does not rise in the delivery tube.

23. In fishes single circulation is present whereas in birds double circulation is present.

The difference between single circulation and double circulation are as follows:

Single Circulation	Double Circulation
Blood moves through heart only once during completion of whole circuit in the body.	Blood passes twice through heart during completion of full circuit.
Only deoxygenated blood flows through heart.	Both oxygenated and deoxygenated blood pass through heart.
Heart pumps blood only to the organ where oxygenation is to occur.	Heart pumps blood to both oxygenating organs and the rest of the body.
Pressure of blood flowing through the body is low.	Pressure of blood flowing through the body is high.
Metabolic rate is low.	Metabolic rate is high.
It is found in pisces.	It is found in amphibian, reptiles, birds and mammals.

OR

Pancreas functions as both endocrine and exocrine gland. Hence, called as dual function gland or a mixed gland.

The two hormones released from pancreas are :

- (i) Insulin - decreases blood sugar level.
- (ii) Glucagon - increases blood sugar level.

24. The phenomenon of change in the direction of propagation of light caused by the large number of particles present in the atmosphere is called scattering of light.

Example : The path of a beam of light becomes visible through a colloidal solution due to scattering of light.

25. The slope of V-I graph gives the resistance of metallic conductor.

Since, slope of V-I graph at temperature T<sub>2</sub> is greater than the slope of V-I graph at temperature T<sub>1</sub>, therefore, resistance at T<sub>2</sub> is greater than resistance at T<sub>1</sub>. Since, resistance of a metallic conductor increases with increase in temperature, therefore, T<sub>2</sub> > T<sub>1</sub>.

OR

(a) (i) Electric current flows from positive terminal to negative terminal of supply source.

(ii) Flow of electron is opposite to the flow of electric current from supply source.

(b) Given : Charge (Q) = 150 coulomb

Time (t) = 1 minute = 60 sec.

Current (I) = ?

$$I = \frac{Q}{t} = \frac{150}{60} = 2.5 \text{ Amp.}$$

26. The brain in human beings is known to be the most delicate organ due to which it is placed inside a bony box. It is contained in a fluid-filled balloon for shock absorption. Spinal cord is located within the vertebral column. The backbone protects it from any injury.

**SECTION-C**

27. (a) Functional group: Aldehyde  
 (b) General formula:  $C_nH_{2n}O$   
 (c) Structure of 4<sup>th</sup> member of this series is:

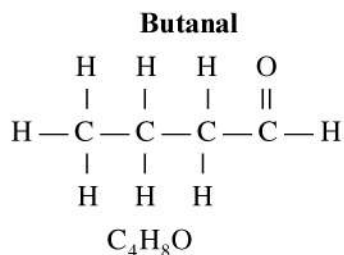

28. (a) The brown colour metal is copper (Cu) and black coloured substance is copper oxide (CuO).  
 (b) (i) When Cu metal is heated in an open china dish then Cu metal gets oxidised.  
 $2\text{Cu} + \text{O}_2 \rightarrow 2\text{CuO}$   
 (ii) When hydrogen gas is passed over the black substance then CuO gets reduced.  
 $\text{CuO} + \text{H}_2 \rightarrow \text{Cu} + \text{H}_2\text{O}$

**OR**

- (a) Hydrogen gas  
 (b) On bringing a burning match stick near the mouth of the test tube, a pop sound is heard.  
 (c) Reaction with acid:



Reaction with base:



29. (a) (2)

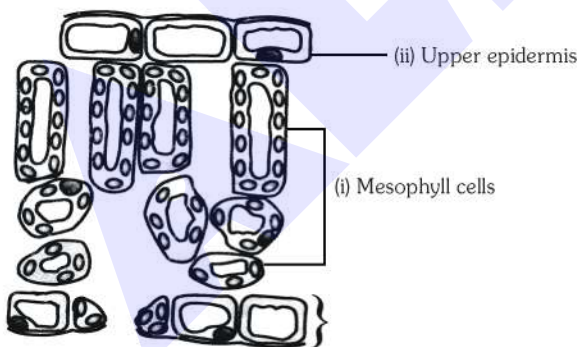

- (b) (1)

Features	Light reaction	Dark reaction
Requirement of light	Required	Not required
Takes place inside	Grana part of the chloroplast.	Stroma region of chloroplast.
ATP and NADPH <sub>2</sub>	ATP and NADPH <sub>2</sub> are produced by the conversion of light energy into chemical energy	ATP and NADPH <sub>2</sub> formed during light reaction are used for the fixation of CO <sub>2</sub> into carbohydrate
Sugar formation	No sugar formation takes place	Sugar formation takes place
Release of oxygen	Oxygen is released	No oxygen is released

30. (a) Decomposers are essential in a biosphere as they breakdown the dead complex organic matter into recyclable simpler compounds. Also, they help in returning the nutrients to the nutrient pool.
- (b) The flow of energy through different steps in the food chain is unidirectional as the energy captured by autotrophs (plants) does not revert back to the solar input and it passes to the herbivores and moves progressively through various trophic levels.
- (c) Ozone is useful in upper part of atmosphere as it protect us from harmful UV-radiations coming from the sun. Ozone is harmful if it is present in lower atmosphere as it is a highly poisonous gas which can kill living organism if it enters along with oxygen in the body.
31. (a) Myopia : A person suffering from this defect can see nearer objects clearly, but cannot see the far-off objects clearly.

Two causes of myopia :

- (i) Excessive curvature of the cornea.  
 (ii) The eye ball gets elongated.

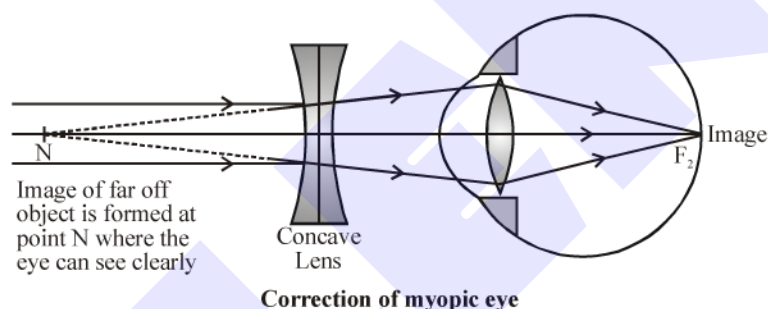

- (b) Given :  $u = -25$  cm,  $v = -1$  m or  $-100$  cm,  $f = ?$

For the correction of hypermetropic eye,

$$\frac{1}{f} = \frac{1}{v} - \frac{1}{u} = -\frac{1}{100} - \frac{1}{-25} = \frac{-1+4}{100} = \frac{3}{100}$$

$$\Rightarrow f = \frac{100}{3} \text{ cm} = \frac{100}{3 \times 100} \text{ m} = \frac{1}{3} \text{ m}$$

$$\therefore \text{Power of the lens, } P = \frac{1}{f(\text{in m})} = \frac{1}{1/3} = +3\text{D}$$

Thus, convex lens having power of 3D is used for the correction of hypermetropic eye.

32. (a) From the S.No.3 we can say that the radius of curvature of the lens is 40 cm because when the object is place at centre of curvature of a convex lens. Its image is formed on the other side of the lens at the same distance from the lens.

$$R = 40 \text{ cm}$$

$$f = \frac{R}{2} = \frac{40}{2} = 20 \text{ cm}$$

- (b) S.No.6 is not correct as the object is between focus and optical centre. Thus, image formed will be on the same side of the lens as the object, i.e.  $v$  must be negative but in S.No.6  $v$  is positive so S.No.6 is incorrect.

(c) Ray diagram for S.No.2.

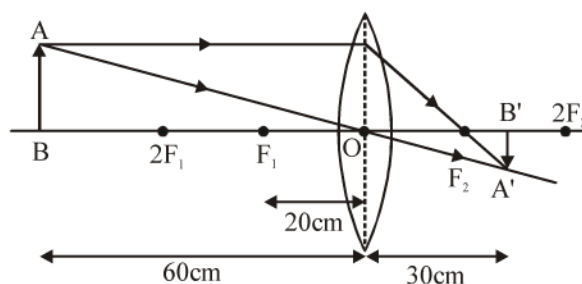

$$\text{Magnification, } m = \frac{v}{u} = \frac{+30}{-60} = -0.5$$

33. (a) It is because the incident ray falls on the mirror along the normal to the reflecting surface. Hence the angle of incidence is zero and according to law of reflection, angle of incidence is always equal to angle of reflection. Therefore the reflected ray goes back along the same path.

(b) (i) Concave mirror.

Concave mirror is used in the headlights of a vehicle because it produces powerful and almost parallel beam of light when the light source is placed at its principal focus.

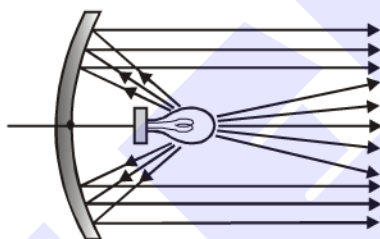

A bulb placed at the focus of a concave mirror produces a strong, almost parallel beam

(ii) Convex mirror.

Convex mirror is used in rear-view mirror of a vehicle. Convex mirror gives a virtual, erect, and diminished image of the object placed in front of it. Because of this, it has a wide field of view. It enables the driver to see most of the traffic behind him.

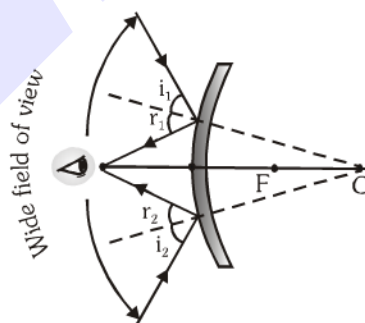

A convex mirror has a wide field of view

### SECTION-D

34. (a) Combustion of ethane :



(b) Oxidation of ethanol:

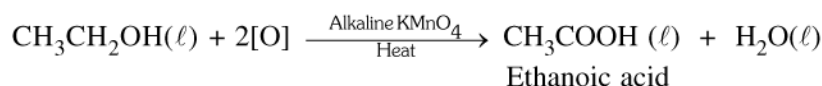

(c) Hydrogenation of ethene:

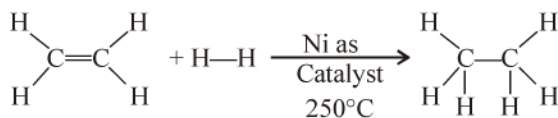

(d) Esterification reaction :

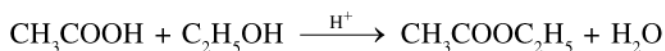

(e) Saponification reaction:

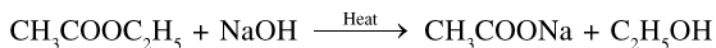

OR

(a) Structural formulae of isomers of Butane are:

n-butane and isobutane.

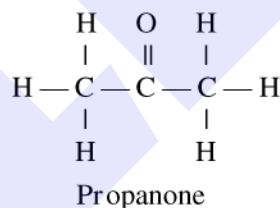
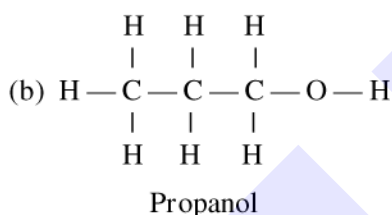
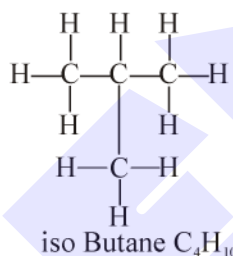
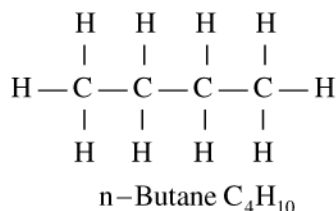

(c) (i) 3<sup>rd</sup> homologue of alkanes is propane (C<sub>3</sub>H<sub>8</sub>).

(ii) 3<sup>rd</sup> homologue of aldehyde is propanal (CH<sub>3</sub>CH<sub>2</sub>CHO)

(d) (i) 2, 3-dimethylbutane

(ii) But-1-ene

35. (a) Sperms are produced in the testes. The testes secrete a hormone called testosterone. Sperms have a long tail that helps them to move towards the female germ cells. Ovum is larger in size and contains the reserve food material. (2)

(b) The process of transfer of pollen grains from the anther to the stigma of a flower is called pollination.

(i) **Self pollination** : It is the transfer of pollen grains from an anther to the stigma of the same plant. If it is in the same flower it is called autogamy (e.g. Pea) and if it is between flowers of the same plant then it is called geitonogamy (e.g. Oxalis). (3)

(ii) **Cross pollination** : It is the transfer of pollen grains from anther to the stigma of different plants of the same species, it is also called xenogamy. (e.g. Mango).

**Significance of pollination** : Pollination is significant because without pollination fertilization will not occur.

OR

- (a) The movement of a part of the plant in response to light is called phototropism. If the plant part moves towards light it is called positive phototropism and if the plant part moves away from light then it is called negative phototropism. (3)

**Role of auxin in phototropism :** When growing plants detect light, a hormone called auxin, synthesized at shoot tip, helps the cells to grow longer. When light is coming from one side of the plant, auxin diffuses towards the shady side of the shoot.

This concentration of auxin stimulates the cells to grow longer on the side of the shoot which is away from light. Thus, the plant appears to bend towards light.

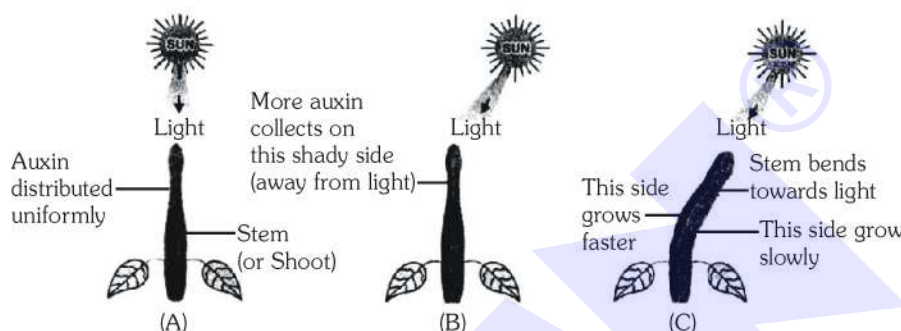

- (b) (i) Kidney helps in removal of harmful nitrogenous wastes from the body. (2)  
 (ii) It also helps in osmoregulation.  
 (iii) It also maintains pH of body fluids.

36. (a) It is observed that total current  $I$  is equal to the sum of separate currents.

$$I = I_1 + I_2 + I_3 \quad \dots(1)$$

Let  $R_p$  be the equivalent resistance of the parallel combination of resistors.

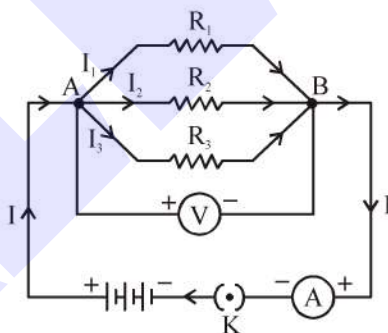

So, by applying ohm's law

$$I = \frac{V}{R_p}$$

$$I_1 = \frac{V}{R_1}, I_2 = \frac{V}{R_2} \text{ and } I_3 = \frac{V}{R_3}$$

So, now from equation (1), we have

$$\frac{V}{R_p} = \frac{V}{R_1} + \frac{V}{R_2} + \frac{V}{R_3} \text{ and } \frac{1}{R_p} = \frac{1}{R_1} + \frac{1}{R_2} + \frac{1}{R_3}$$

Hence, if  $n$  resistors are connected in parallel, then the equivalent resistance of the circuit is given by -

$$\frac{1}{R_{eq}} = \frac{1}{R_1} + \frac{1}{R_2} + \frac{1}{R_3} + \dots + \frac{1}{R_n}$$

(b) To get the minimum resistance all the resistors are connected in the parallel combination. Hence the equivalent resistance is given by

$$\frac{1}{R} = \frac{1}{20} + \frac{1}{20} + \frac{1}{20} + \frac{1}{20}$$

$$\frac{1}{R} = \frac{4}{20}$$

$$R = \frac{20}{4} = 5 \text{ ohm}$$

OR

Energy consumed per day by refrigerator =  $0.4 \text{ kW} \times 10 \text{ h}$

Power of refrigerator =  $400 \text{ W} = \frac{400}{1000} \text{ kW} = 0.4 \text{ kW} = 4 \text{ kW}$

Energy consumed per day by fans =  $2 \times 0.08 \text{ kW} \times 6$

Power of each =  $80 \text{ W} = \frac{80}{1000} = 0.08 \text{ kW} = 0.96 \text{ kWh}$

Energy consumed by lights =  $6 \times 0.018 \text{ kW} \times 6 \text{ h} = 0.648 \text{ kWh}$

Total energy consumed per day =  $4 + 0.96 + 0.648 = 5.608 \text{ kWh}$

Energy consumed in 30 days =  $30 \times 5.608 = 168.24 \text{ kWh}$

Cost of 168.24 units @ ₹3.00 =  $168.24 \times 3 = ₹504.72$

### SECTION-E

37. (a) Electron transfer in the formation of magnesium chloride:

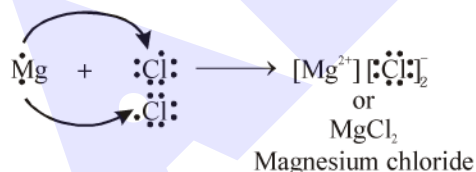

(b) Two properties of ionic compounds are :

- (i) They conduct electricity in a solution or molten state.
- (ii) They are hard and brittle crystalline solids.

(c) Sodium chloride is formed by the combination of sodium and chloride ions. Sodium loses one electron from the valence shell to attain a stable noble gas configuration.

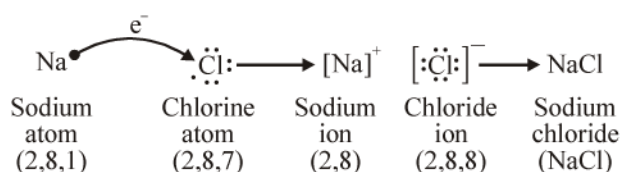



OR

(c) (i) Ionic compounds do not conduct electricity in a solid state due to the absence of free ions but they conduct electricity in a molten and aqueous state due to the presence of free ions.

(ii) Reduction takes place at cathode. Therefore, during electrolysis of an molten solution of sodium chloride, sodium metal is evolved at cathode due to the reduction of  $\text{Na}^+$  ions.



38. (a) The given cross can be represented as

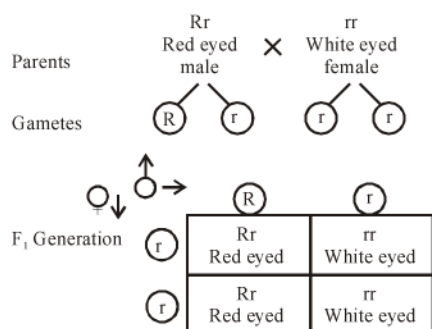

The genotype of red eyed progenies for the given cross is Rr.

(b) The ratio of red eyed progenies to white eyed progenies in the above cross is 1 : 1.

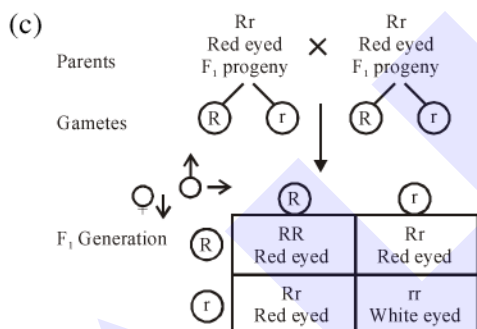

The ratio of their progenies that are heterozygous for red eyes is 1 : 2.

OR

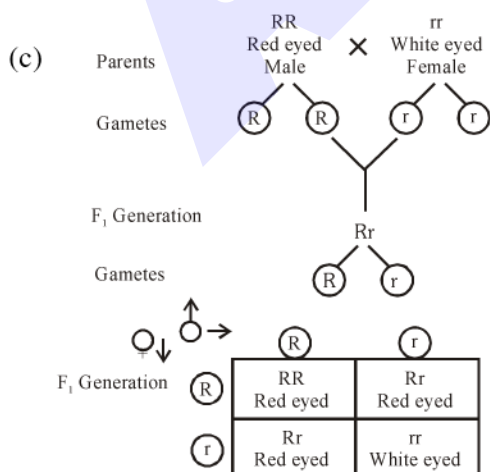

Cross breeding

Self pollination

**Phenotypic ratio**

3 Red eyed : 1 White eyed

**Genotypic Ratio**

1 Pure Red eyed (RR) : 2 Hybrid Red eyed (Rr) : 1 Pure White eyed (rr)

39. (a) When a current-carrying conductor is placed in a magnetic, a mechanical force is exerted on the conductor which makes rod displaced.
- (b) Fleming's left hand rule determines the direction of the force on the conductor AB According to this rule, stretch the thumb, forefinger and middle finger of your left hand such that they are mutually perpendicular. If the first finger point in the direction of magnetic field and the second finger in the direction of current, then the thumb will point in the direction of motion or the force acting on the conductor.
- (c) (i) Towards the left.  
 (ii) Electric motor and electric generator.

OR

