

**PAPER # 01 - SCIENCE**
**SOLUTIONS  
SCIENCE**

1. (c) The reaction of a metal with an acid
2. (b)  $\text{MnO}_2$  is reduced to  $\text{MnCl}_2$  &  $\text{HCl}$  is oxidized to  $\text{Cl}_2$
3. (a) By adding acid to water with constant stirring
4. (a)  $\text{Na}_2\text{CO}_3$
5. (b) y is non-metal and z is a metal
6. (d) Amalgam
7. (c) 16 Covalent bonds
8. (d) Shark, Dogfish, Sting ray
9. (b) II, III
10. (b) Sexual reproduction
11. (a) Electrical – chemical signals
12. (b) Emasculation
13. (c) Between C and F
14. (a) real
15. (d) (ii) and (iv)
16. (b) Urea
17. (a) Both A and R are true and R is the correct explanation of A.
18. (a) Both A and R are true and R is the correct explanation of A.
19. (c) (A) is true but (R) is false
20. (b) Both A and R are true but R is not the correct explanation of A.
21. Methanoic acid ( $\text{HCOOH}$ )  
Use of baking soda can give relief on the stung area when applied on it.

**OR**

- (a) When sodium hydrogen carbonate is heated, sodium carbonate, Carbon dioxide and water are formed.
- (b)  $2\text{NaHCO}_3(\text{s}) \rightarrow \text{Na}_2\text{CO}_3 + \text{H}_2\text{O}(\text{l}) + \text{CO}_2(\text{g})\uparrow$
22. (i) PNS – Peripheral nervous system  $\left(\frac{1}{2}\right)$   
Medulla –  $\left(\frac{1}{2}\right)$   
(ii) Gustatory – Tongue  $\left(\frac{1}{2}\right)$   
Olfactory – Nose  $\left(\frac{1}{2}\right)$
23. (i) Bread contains starch which is acted upon by salivary amylase to form sweet sugar maltose  
(ii) Human being have no enzyme for digestion of cellulose, it is roughage in human being .  
In cow, cellulose digesting enzyme and fermenting bacteria are present which convert cellulose in nutrient containing sugar.
24. Coils of electric toasters and electric irons are made of an alloy rather than a pure metal because  
(i) the resistivity of an alloy is much higher than that of pure metal and

- (ii) an alloy does not undergo oxidation easily even at high temperature.  
 (iii) alloy have high melting point.

25. The potential difference between two points in a current carrying conductor is said to be 1 V when 1 joule of work is done to move a charge of 1 coulomb from one point to the other.

$$\text{Therefore, } 1 \text{ volt} = \frac{1 \text{ joule}}{1 \text{ coulomb}}$$

$$1 \text{ V} = 1 \text{ JC}^{-1}$$

26.

	<b>Aerobic Respiration</b>	<b>Anaerobic Respiration</b>
1	It occurs in the presence of oxygen	It occurs in the absence of oxygen
2	There is complete breakdown of glucose into $\text{CO}_2 + \text{H}_2\text{O} + \text{energy}$	There is incomplete breakdown of glucose either in ethyl alcohol + $\text{CO}_2 + \text{energy}$ or Lactic acid + energy ( <i>any other two difference</i> )

**OR**

(i) Due to lack of oxygen, muscles do anaerobic respiration, formation and accumulation of lactic acid causes muscle cramps.

(ii) Leakage will result in loss of blood. Platelets help in clot formation and prevent blood loss.

27.

(a)  $\text{G} = \text{Cl}_2$  ;  $\text{C} = \text{CaOCl}_2$

(b)  $\text{Ca}(\text{OH})_2 + \text{Cl}_2 \rightarrow \text{CaOCl}_2 + \text{H}_2\text{O}$

(c) Common name – bleaching powder

Chemical name – calcium oxychloride

28.

(a) The reaction is highly exothermic reaction & metals (Fe/Mn) obtained will be in molten state.

(b) Substance oxidized –  $\text{Al}_{(s)}$

Substance reduced –  $\text{Fe}_2\text{O}_{3(s)}$

(c) Al is more reactive than Fe/Mn

29.

(i) Because birds and mammals have high energy demand to maintain their body temperature and need continuous supply of oxygen. Therefore to avoid mixing of blood separation of these two types of blood is necessary.

(ii) Left ventricle has to pump blood with great force to send to farther parts of body so avoid bursting it has thick wall on the other hand right ventricle pumps blood to lungs only with does not required great force.

(iii) Blood flow with great pressure in arteries to avoid bursting they have thick wall.

To prevent backflow of blood vein have valves.

**OR**

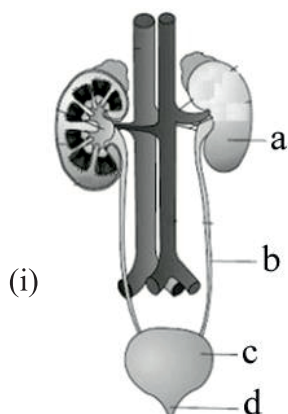

[2]

(ii) Water and glucose (*any other*)

[ $\frac{1}{2} + \frac{1}{2}$ ]

30. The sex of the child determined at the time of fertilization depending upon which type of sperm fuses with ovum. If sperm (male gamete) having X chromosome which fuses with ovum (Female gamete) having X chromosome, then the offspring will have XX sex chromosome and will be a girl child. On the other hand, if sperm having Y chromosome fuses with ovum having X chromosome, then the offspring will be a boy have XY combination of sex chromosomes. Therefore there is 50% - 50% probability of a girl or boy being born in the family

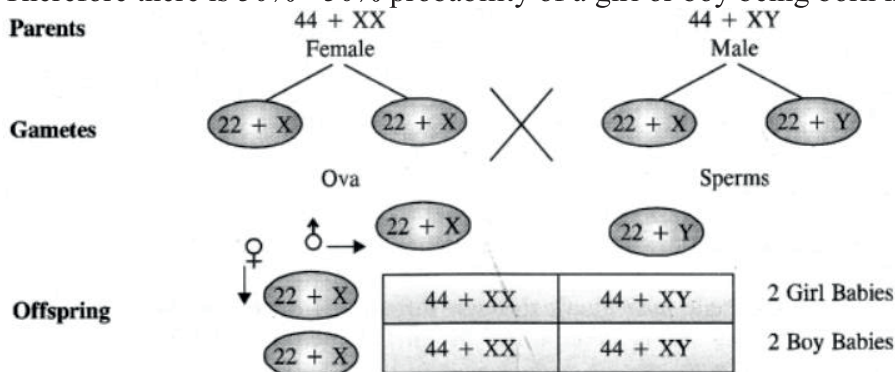

50% - 50% chances of being born as girl or boy.

31. (i) Snell's law of refraction states that the ratio of sine of angle of incidence to sine of angle of refraction is a constant for a given pair of media and a given colour of light. This constant is refractive index of second medium with respect to the first.

(ii) Refraction through a glass slab

AB - incident ray

CD - emergent ray

$\angle I = \angle C$

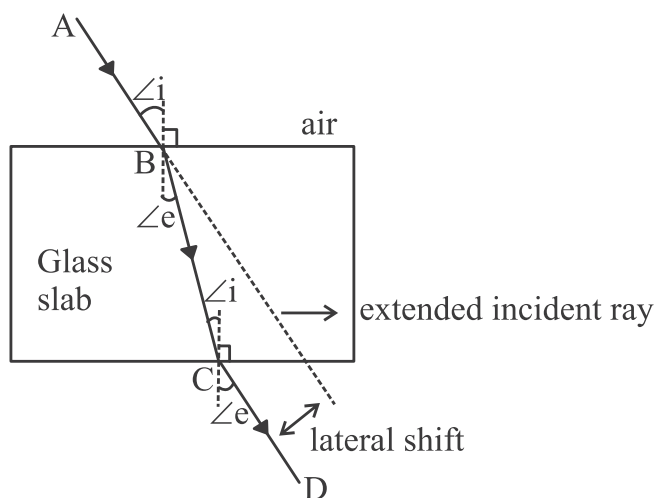

32. For convex mirror, we are given,  $u = -10$  m,  $R = 2.0$  m

So, 
$$f = \frac{R}{2} = \frac{2.0 \text{ m}}{2} = 1.0 \text{ m}$$

Using the mirror formula, 
$$\frac{1}{u} + \frac{1}{v} = \frac{1}{f}$$

We get 
$$\frac{1}{v} = \frac{1}{f} - \frac{1}{u} = \frac{1}{1.0} + \frac{1}{10} = \frac{11}{10}$$
 or,  $v = \frac{10}{11} = 0.9 \text{ m}$

Thus, the car would appear at 0.9 m from the convex mirror. We know that

$$m = \frac{v}{u} = \frac{-10}{-11} = \frac{1}{11}$$

Thus, size of the image of the car will be fraction of  $\frac{1}{11}$  the actual size of the car through the convex mirror.

- 33.** (i) Magnetic field at P is into the plane of paper and at Q it is out of the plane of paper. The strength of the magnetic field at Q will be larger as strength of the field  $\propto \frac{1}{r}$ .

(ii) (a) The direction of the magnetic field at a point can be found by placing a small magnetic compass at the point where it is placed.

(b) The direction of magnetic field at the centre of a current-carrying circular loop is perpendicular to the plane of the loop.

**OR**

Resistance of combination of three bulbs in parallel

$$R_{eq} = \frac{V}{I} = \frac{4.5}{I} = \frac{4.5}{3} = 1.5 \Omega$$

If R is the resistance of each wire, then

$$R_{eq} = \frac{1}{R} + \frac{1}{R} + \frac{1}{R}$$

$$\text{or } \frac{1}{R_{eq}} = \frac{3}{R}$$

$$\text{or, } R = 3R_{eq} = 3 \times 1.5 = 4.5 \Omega$$

$$\text{Current in each bulb, } I = \frac{V}{R} = \frac{4.5 \text{ V}}{4.5 \Omega} = 1 \text{ A}$$

(i) When bulb  $B_1$  gets fused, the currents in  $B_2$  and  $B_3$  remain same  $I_2 = I_3 = 1 \text{ A}$ , so their glow remains unaffected.

(ii) When bulb  $B_2$  gets fused, the current in  $B_2$  becomes zero and currents in  $B_1$  and  $B_3$  remains 1 A.

$$\text{Total current } I = I_1 + I_2 + I_3 \\ = 1 + 0 + 1 = 2 \text{ A}$$

Current in ammeter  $A_1 = 1 \text{ A}$

Current in ammeter  $A_2 = 0$

Current in ammeter  $A_3 = 1 \text{ A}$

Current in ammeter  $A = 2 \text{ A}$

(iii) When all the three bulbs are connected.

$$\text{Power dissipated, } P = \frac{V^2}{R_{eq}} = \frac{(4.5)^2}{1.5} = 13.5 \text{ W}$$

**34.** x = Ethanol ( $C_2H_5OH$ )

y = Ethene ( $C_2H_4$ )

z = Hydrogen ( $H_2$ )

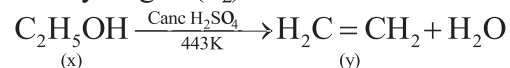

$H_2SO_4$  act as a dehydrating agent which removes

a molecule of water from ethanol to give unsaturated compound "Ethene"

OR

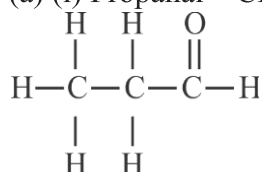
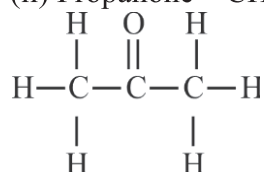
(a) (i) Propanal –  $\text{CH}_3\text{CH}_2\text{CHO}$ (ii) Propanone –  $\text{CH}_3\text{COCH}_3$ (b) (i)  $\text{CH}_3\text{COOC}_2\text{H}_5 + \text{NaOH} \rightarrow \text{CH}_3\text{COONa} + \text{C}_2\text{H}_5\text{OH}$ (ii)  $\text{CH}_3\text{COOH} + \text{NaOH} \rightarrow \text{CH}_3\text{COONa} + \text{H}_2\text{O}$ (iii)  $\text{C}_2\text{H}_5\text{OH} + \text{CH}_3\text{COOH} \xrightarrow{\text{H}^+} \text{CH}_3\text{COOC}_2\text{H}_5 + \text{H}_2\text{O}$ 

35.

(i) Pancreas – Insulin

Pituitary – Growth hormone

(ii) We should consume iodized salt, because little amount of mineral iodine is necessary for synthesis of thyroxin from the thyroid gland.

Lack of iodine causes goiter (swelling neck) disorder

(iii) Recessive gene – It is an allele of a gene which is unable to express its effect in the presence of its contrasting allele.

Dominant gene – It is an allele of a gene which can express its effect whether present in homozygous or heterozygous state

OR

(i) Inner wall of uterus degrade, excessive secretion of mucus occurs, blood vessels break off that causes bleeding, unfertilized egg ruptures, these all come out through vagina termed as menstruation.

(ii) Fallopian tube is the site for fertilization so it help in pregnancy, if fertilization occurs.

Fallopian tubes are surgically cut and knot are formed that prevent fertilization and subsequent pregnancy.

(iii) (a) Viral – AIDS, warts

Bacterial – Gonorrhoea, syphilis

(b) Condom

36.

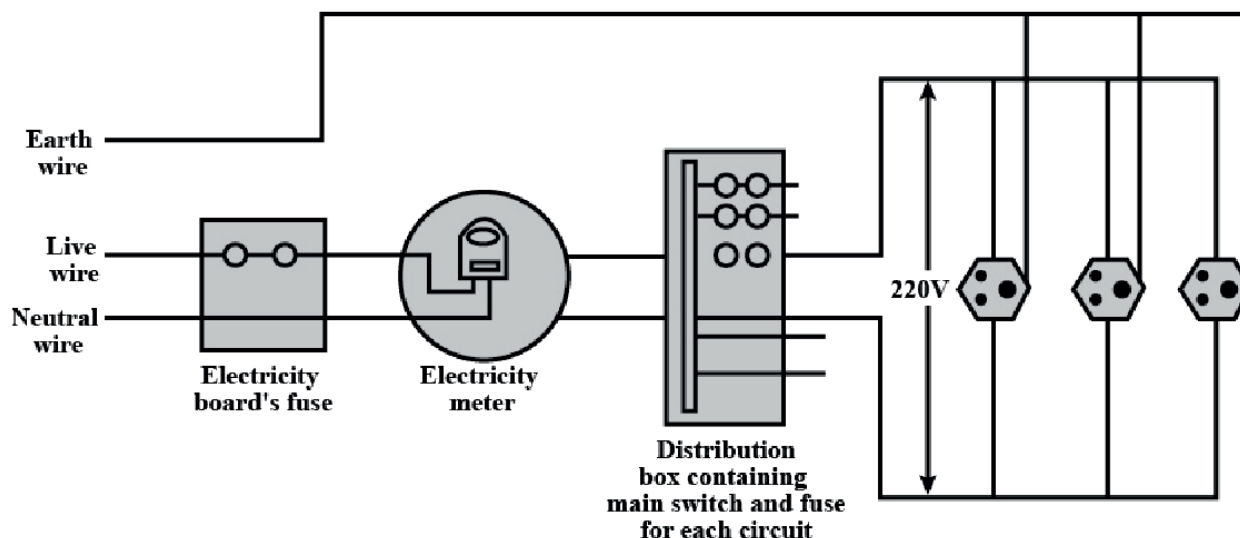

A fuse in a circuit prevents damage to the appliances and the circuit due to overloading. Otherwise, the appliances or the circuit may be damaged.

When current in the circuit exceeds the value of fuse rating, the fuse wire burns due to the overloading. This causes a gap in the circuit and the current stops flowing in the circuit.

This is done due to the reason so that the circuit or the appliances to be connected in the circuit continue functioning without any damage in future.

OR

(i) Ammeter measures electric current

The unit of electric current is ampere (A). 1 ampere is constituted by the flow of 1 coulomb of charge through any point in an electric circuit in 1 second.

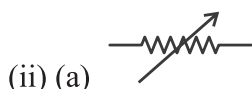

Variable resistance or rheostat

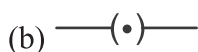

Plug key or switch (closed)

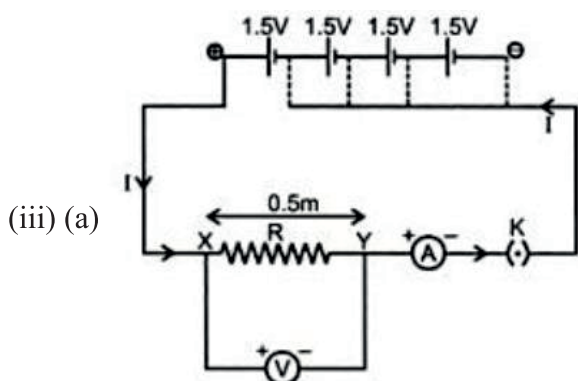

(b) Following graph was plotted between V and I values.

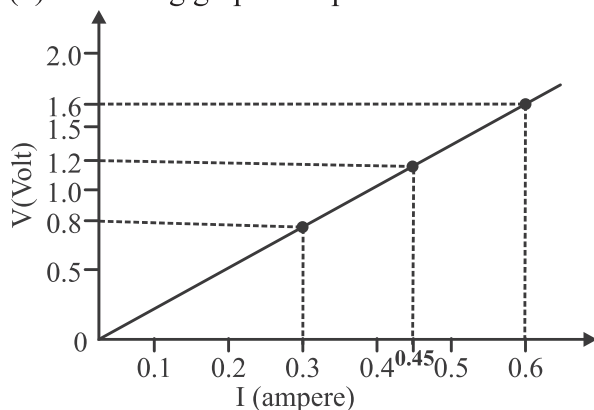

At potential difference 0.8 V,

$$\frac{V}{I} = \frac{0.8}{0.3} = \frac{8}{3}$$

At potential difference 1.2 V,

$$\frac{V}{I} = \frac{1.2}{0.45} = \frac{8}{3}$$

At potential difference 1.6 V,

$$\frac{V}{I} = \frac{1.6}{0.6} = \frac{8}{3}$$

Conclusion : If I be the current through XY resistor and V be the potential difference across it,

then the ratio  $\frac{V}{I} = \text{constant}$ .

$\Rightarrow V \propto I$  and ohm's law is obeyed.

37. (i) (b) Refining

Explanation: Refining of metal is the process of purification of the metal obtained after reduction.

(ii) (a) (i) and (ii)

Explanation: Na and K are highly reactive metals. They are obtained by electrolytic reduction. Electrolytic refining is used for metals like Cu, Zn, Ag, Au etc.

(iii) Positive and oxidation.

**OR**

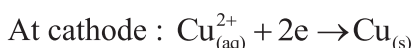
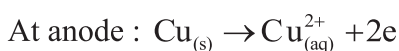

38. (i) Grass  $\rightarrow$  Insects  $\rightarrow$  Frog  $\rightarrow$  Snake  $\rightarrow$  Hawk

(ii) Hawk, Biomagnification

(iii) (a) There is unidirectional flow of energy from Sun to producers and from producers to various levels of consumers. The energy captured by the produces does not revert back to solar Input similarly energy which passes to herbivores not come back to producers.

(b) This law states that during transfer of energy from one trophic level to the next level, only about 10% energy is available to the higher trophic level and the remaining 90% is lost in the respiration and heat.

**OR**

(iii) (a) Decomposers act on dead and decayed organic matter and return the nutrients back to the environment. They clean the environment.

(b) Ecosystem is self-sustained unit of biosphere where interactions occur between biotic community and their physical environment.

39. (a)  $P = P_1 + P_2 = 4 - 2 = +2 \text{ D (Convex lens)}$

Nature of combination is converging.

(b)  $P = -2.5 \text{ D}$  ;  $f = ?$

$$P = \frac{100}{f(\text{cm})}$$

$$-2.5 = \frac{100}{f(\text{cm})}$$

$$f(\text{cm}) = \frac{-100}{2.5} = \frac{-1000}{25} = -40$$

$$F = -40 \text{ cm}$$

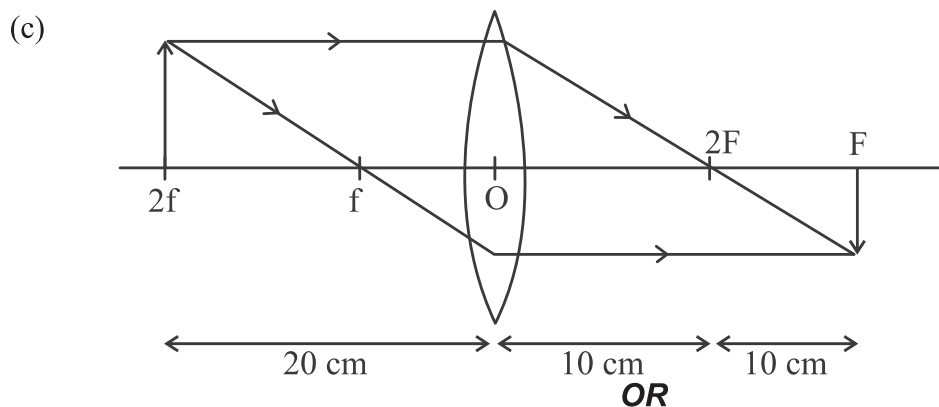

- (c) Virtual image formed by convex lens  
 -Magnified (enlarged) & erect while virtual image formed by concave lens is diminished and erect.  
 For convex lens- When object is placed between optical centre and focus image formed is virtual, erect & magnified.  
 For concave lens- When object is placed anywhere in front of the concave lens, image formed is virtual, erect & diminished.